

— CONSTRUCTION —

2022 FULL LINE
PRODUCT CATALOG



GRK[®] FASTENERS[™]

GREATNESS AT EVERY TURN

GRK Fasteners offers a wide selection of fasteners that includes multipurpose, structural, deck, trim, cabinet, composite and stainless screws, but they all have one thing in common—quality.

GRK Fasteners allows users to complete jobs with more productivity. Our patented W-Cut[™] Threadform feature reduces installation torque and allows fast driving and ease of install, the recessed Star Drive eliminates recess stripping for improved productivity, and the Zip-Tip[™] feature eliminates the need for pre-drilling and allows one-step installation. GRK's feature-rich screws drive jobsite productivity and allow users to keep moving from one job to the next.

GRK fasteners are corrosion resistant, approved for use in treated lumber and designed for both interior and exterior use.



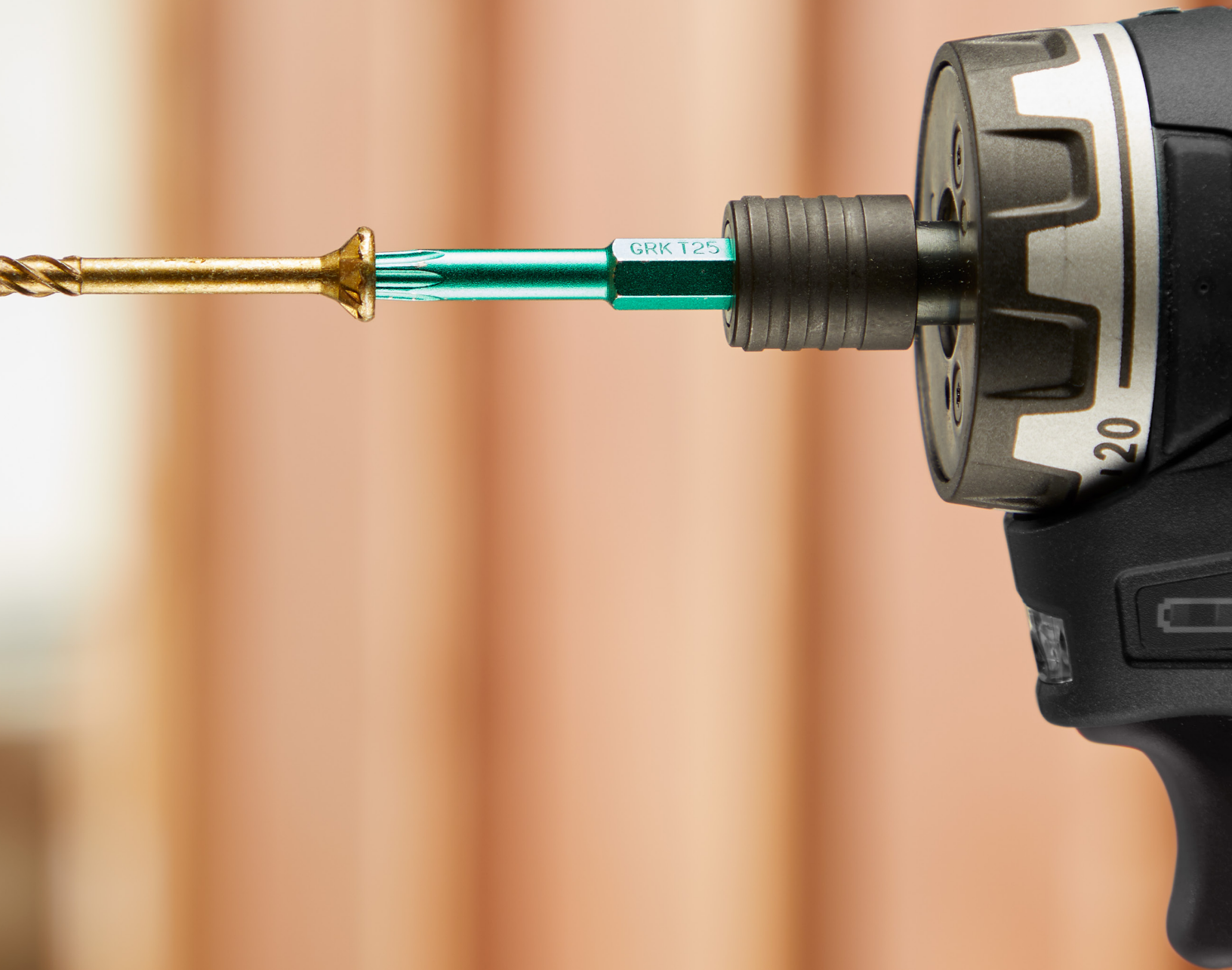

R4™ MULTI-PURPOSE FRAMING & DECKING SCREWS



FASTER DRIVE FOR IMPROVED PRODUCTIVITY

GRK's R4™ Multi-purpose Screw is a versatile, code-approved fastener for hundreds of applications. Its feature-rich design provides a fast and reliable connection every time.

- **Fast Bite Tip:** Provides a fast start for one-step installation
- **Zip-Tip™:** Eliminates pre-drilling
- **W-Cut™:** Low torque, faster drive
- **Precision Fit:** Reduces wobble between R4 screws and GRK bits for improved productivity¹
- **CEE Thread™:** Enlarges hole to reduce splitting²
- **Star Drive Recess:** Zero stripping, with 6 points of contact
- **Underhead Cutting Teeth:** Cuts wood fiber & provides flush seating
- **GRK Head Markings:** Easy identification of genuine GRK screws
- **Climatek™ Coating:** ICC-ES AC257 code approved for use in treated lumber³
- **Code Approved:** For structural applications (see ESR-3201)⁴
- Some sizes also available in PHEINOX™ 305 and 316 grade Stainless Steel • For interior / exterior use



ESR-3201



AC257 Treated
Lumber Approved

1. Precision Fit included on #9 and #10 sizes only
2. CEE Thread included on fasteners 2" and longer
3. For cedar, redwood and other naturally protected woods, GRK Pheinox™ 305 and 316 stainless steel is recommended
4. ICC Code Approval for #9, #10, and #12 sizes only

	U.S. (Std.) Size (Dia. x Length)	Bulk Part No.	Bulk Box Qty.	Contractor Packs (XL buckets) Part No.	Contractor Packs (XL buckets) Qty.	Pro- Pak Part No.	Pro-Pak Pail Qty.	Handy-Pak Part No.	Handy-Pak MC Qty./ Screw Qty. (per EA)
T-15	#6 x 1-1/4"	00051	13,000						
	#8 x 1-1/4"					01069	1,300	96080	4 / 110
T-15	#8 x 1-1/2"	00073	6,500			01073	1,000	96085	4 / 110
	#8 x 1-3/4"					01075	925	02075	20 / 100
	#8 x 2"	00077	4,500			01077	850	02077	20 / 100
	#8 x 2-1/2"	00079	3,500			01079	650	02079	20 / 100
	#9 x 1-1/4"	00091	8,000						
T-25	#9 x 1-1/2"	00095	5,200			01095	820	02095	20 / 100
	#9 x 1-3/4"	00097	4,500						
	#9 x 2"	00099	3,700	120990	990	01099	690	103099	4 / 110
	#9 x 2-1/2"	00101	2,900	121010	900	01101	575	103101	4 / 100
	#9 x 2-3/4"	00103	2,000			01103	480	02103	10 / 100
	#9 x 3-1/8"	00105	1,900	121050	720	01105	425	103105	4 / 80
	#10 x 2"	00131	3,200						
	#10 x 2-1/2"	00133	2,500			01133	470	103133	4 / 80
T-25	#10 x 2-3/4"	00135	2,000						
	#10 x 3-1/8"	00137	1,500	95200	630	01137	350	103137	4 / 70
	#10 x 3-1/2"	00139	1,200			01139	300	02139	10 / 50
	#10 x 4"	00141	1,000	121410	450	01141	270	103141	4 / 50
	#10 x 4-3/4"	00143	800			01143	230	02143	10 / 50
T-25	#12/14 x 5-5/8"	00173	600					96089	4 / 50
	#12/14 x 6-3/8"	00177	1,000					02177	9 / 50
	#12/14 x 8"	00181	500					02181	9 / 50



APPLICATIONS:

- Multi-Purpose Framing
- Interior and Exterior Remodeling
- Porches and Patios
- Fencing
- Exterior Structures

- Pro-Paks need to be ordered in multiples of two
- 2" bit included in Pro-Paks. 1" bit with Handy-Paks

RSS™ STRUCTURAL RUGGED STRUCTURAL SCREWS



EASY TO INSTALL LAG ALTERNATIVE

GRK's RSS™ Rugged Structural Screw is a structural fastener designed for ease of installation and the strongest of connections. RSS fasteners drive into most woods without the need for pre-drilling. The specially engineered design results in a low-effort installation, especially compared to conventional lag screws.

- **Fast Bite Tip:** Provides a fast start for one-step installation
- **Zip-Tip™:** Eliminates pre-drilling¹
- **W-Cut™:** Low torque, faster drive
- **Precision Fit:** Reduces wobble between RSS screws and GRK bits for improved productivity²
- **Integrated Washer Head:** Maximum clamping force
- **Star Drive Recess:** Zero stripping, with 6 points of contact
- **GRK Head Markings:** Easy identification of genuine GRK screws
- **CEE Thread™:** Enlarges hole to reduce splitting³
- **Climatek™ Coating:** ICC-ES AC257 code approved for use in treated lumber³
- **Code Approved:** For structural applications (see ESR-2442)⁴
- Some sizes also available in PHEINOX™ 305 and 316 grade Stainless Steel • For interior / exterior use







ESR-2442



AC257 Treated
Lumber Approved

1. Zip-Tip included on fasteners 2-1/2" and longer
2. Precision Fit included on 5/16" sizes only
3. CEE Thread included on fasteners 3-1/8" and longer
4. For cedar, redwood and other naturally protected woods, GRK Pheinox™ 305 and 316 stainless steel is recommended
5. ICC Code Approval for 1/4", 5/16", and 3/8" sizes only

	U.S (Std.) Size (Dia. x Length)	Bulk Part No.	Bulk Box Qty.	Pro- Pak Part No.	Pro- Pak Pail Qty.	Handy- Pak Part No.	Handy-Pak MC Qty./ Screw Qty. (per EA)	RSS [™] Mini Handy-Pak Part No.	RSS [™] Mini Handy-Pak MC Qty./ Screw Qty. (per EA)	RSS [™] Individually Tagged Pt. No.(Qty./ Ctn.)
 T-25	#10 x 2-1/2"	10133	1,000			12133	10 / 50			
	#10 x 3-1/8"	10137	800	11137	236	12137	10 / 50			
 T-25	1/4" x 1-1/2"	10151	1,000			12151	20 / 50			
	1/4" x 2"	10155	800			12155	10 / 50			
	1/4" x 2-1/2"	10157	700							
	1/4" x 3-1/8"	10161	500			12161	10 / 50			
 T-30	5/16" x 2-1/2"	10217	600			12217	9 / 100			
	5/16" x 2-3/4"	10219	500			12219	2 / 100			
	5/16" x 3-1/8"	10221	500			12221	2 / 100	14221	10 / 25	96001 (1/50)
	5/16" x 3-1/2"	10223	500			12223	2 / 100			
	5/16" x 4"	10225	400			12225	2 / 100	14225	10 / 25	96005 (1/50)
	5/16" x 5-1/8"	10231	300			12231	9 / 50	14231	10 / 25	96010 (1/50)
	5/16" x 6"	10235	300			12235	9 / 50	14235	10 / 25	96015 (1/40)
 T-40	3/8" x 3-1/8"	10273	400							
	3/8" x 4"	10275	400			12275	9 / 50			
	3/8" x 6"	10281	300			12281	2 / 50			
	3/8" x 7-1/4"	10285	200			12285	2 / 50			
	3/8" x 8"	10287	300			12287	2 / 50			96020 (1/25)
	3/8" x 10"	10293	300			12293	2 / 50			96025 (1/25)
	3/8" x 12"	10299	300			12299	2 / 50			96030 (1/20)
	3/8" x 14-1/8"					12307	2 / 50			
	3/8" x 16"	10311	100			12311	2 / 50			
RSS[™] JTS - JOIST AND TRUSS SCREW										
 T-25	1/4" x 5"					93735	9 / 50			
	1/4" x 6-3/4"	91743	300			93743	9 / 50			

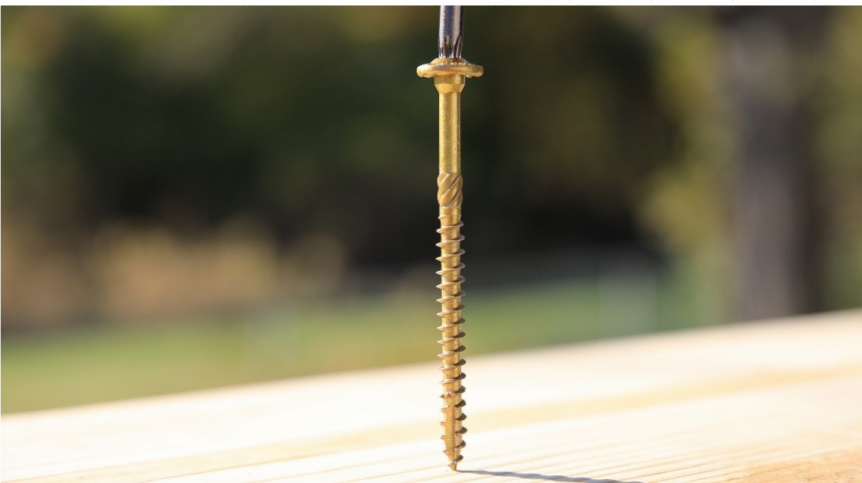

APPLICATIONS:

- Structural Decking
- Heavy Duty Framing
- LVL Fastening
- Ledger Boards
- Multi-ply
- Interior and Exterior Remodeling

- Pro-Paks need to be ordered in multiples of two
- 2" bit included in Pro-Paks. 1" bit with Handy-Paks

DECK ELITE

DECKING SCREWS





SPEED. QUALITY. ELEVATED CRAFTSMANSHIP

GRK's Deck Elite screws are designed for use in wood deck boards and provide a quick drive and clean finish. Deck Elite screws start immediately in wood with a smooth, fast drive to increase productivity on the job and the tan color of the screw provides an ideal finish.

- **Tan Color:** Provides an ideal finish
- **Fast Bite Tip:** Provides a fast start for one-step installation
- **Zip-Tip™:** Eliminates pre-drilling
- **W-Cut™:** Low torque, faster drive
- **CEE Thread™:** Enlarges hole to reduce splitting¹
- **Star Drive Recess:** Zero stripping, with 6 points of contact
- **GRK Head Markings:** Easy identification of genuine GRK screws
- **Corrosion Resistant Coating:** Resists rust and keeps decks looking new
- For use in wood deck boards, fencing, and deck rails, including pressure treated lumber²
- For interior / exterior use

1. CEE Thread included on fasteners 2" and longer
2. For cedar, redwood and other naturally protected woods, GRK Pheinox™ 305 and 316 stainless steel is recommended

	U.S (Std.) Size (Dia. x Length)	Contractor Packs (XL buckets) Part No.	Contractor Packs (XL buckets) Qty.	Pro-Pak Part No.	Pro-Pak Pail Qty.
 T-15	#8 x 2	40803	1,080	10803	540
	#9 x 1-5/8"	49159	1,080	19159	540
 T-25	#9 x 2-1/2"	49212	800	19212	400
	#9 x 3"	40903	700	10903	350

- Contractor Packs and Pro-Paks need to be ordered in multiples of two
- 2" bit included in Pro-Paks. 1" bit with Contractor Packs



APPLICATIONS:

- Deck Boards
- Fencing
- Deck Rails

FIN/TRIM™

FINISHING TRIM HEAD SCREWS

PROFESSIONAL FINISH, PROFESSIONAL LOOK

GRK's Fin/Trim™ screws are an excellent choice for most fine carpentry applications, as well as window extension jambs, joining cabinets and more. A combination of the smallest screw head available and code approved structural performance means the most secure, concealed fastening in the industry.

- **Trim Head:** Clean, finished look
- **Star Drive Recess:** Zero stripping, with 6 points of contact
- **W-Cut™:** Low torque, faster drive
- **Zip-Tip™:** Eliminates pre-drilling
- **Climatek™ Coating:** ICC-ES AC257 code approved for use in treated lumber¹
- **Code Approved:** For structural applications (see ESR-3201)
- Some sizes also available in PHEINOX™ 305 and 316 grade Stainless Steel• For interior / exterior use





ESR-3201



AC257 Treated
Lumber Approved

1. For cedar, redwood, and other naturally-protected woods, GRK recommends PHEINOX™ stainless steel fasteners

	U.S (Std.) Size (Dia. x Length)	Bulk Part No.	Bulk Box Qty.	Pro-Pak Part No.	Pro-Pak Pail Qty.	Handy-Pak Part No.	Handy-Pak MC Qty./Screw Qty. (per EA)
 T-10	#8 x 1-1/4"					96055	6 / 100
	#8 x 1-1/2"	15724	6,500	116724	600	119724	6 / 100
	#8 x 2"	15728	4,500	116728	510	119728	6 / 100
	#8 x 2-1/2"	15730	3,500	16730	605	119730	6 / 100
	#8 x 2-3/4"					17732	20 / 100
	#8 x 3-1/8"	15734	2,500	115734	300	119734	6 / 100
 T-15	#9 x 4"	15760	1,000			117760	4 / 50
	#9 x 5"	15766	800			117766	4 / 50
White Fin/Trim[™]							
 T-10	#8 x 2"			16828	605	96060	4 / 100
	#8 x 2-1/2"			16830	505	96065	4 / 100

- Pro-Paks need to be ordered in multiples of two
- 2" bit included in Pro-Paks. 1" bit with Handy-Paks



APPLICATIONS:

- Trim Work
- Cabinets
- Fine Carpentry

RT COMPOSITE™

EXTERIOR TRIM SCREW

INSTALL RIGHT THE FIRST TIME

The RT Composite™ screw is a specially designed fastener for attaching composite and cellular PVC materials. Reverse threading under the head of the fastener helps the screw head disappear beneath the surface of the classic wood composite material while reducing or eliminating the dimple that is common in this substrate.

- **Trim Head:** Clean, finished look
- **Underhead Reverse Thread:** Reduces or eliminates mushrooming
- **Star Drive Recess:** Zero stripping, with 6 points of contact
- **W-Cut™:** Low torque, faster drive
- **Zip-Tip™:** Eliminates pre-drilling
- **Climatek™ Coating:** ICC-ES AC257 code approved for use in treated lumber¹
- Available in Climatek or White Climatek coated finish
- Some sizes also available in PHEINOX™ 305 and 316 grade Stainless Steel• For interior / exterior use



ESR-3201



AC257 Treated
Lumber Approved

1. For cedar, redwood, and other naturally-protected woods, GRK recommends PHEINOX™ stainless steel fasteners



T-10



T-15

U.S (Std.) Size (Dia. x Length)	Bulk Part No.	Bulk Box Qty.	Pro-Pak Part No.	Pro-Pak Pail Qty.	Handy-Pak Part No.	Handy-Pak MC Qty./Screw Qty. (per EA)
#8 x 2"			16077	725	119077	6 / 100
#8 x 2-1/2"	15079	3,500	16079	605	119079	6 / 100
#8 x 3-1/8"	15083	2,500	16083	514	119083	6 / 100
#9 x 2-1/2"	15101	2,900	16101	408		
#9 x 3-1/8"	15105	1,900	16105	348		

White RT Composite[™]



T-10

#8 x 2"			16628	605	17628	20 / 100
#8 x 2-1/2"			16630	505	96075	4 / 100
#8 x 2-3/4"					17632	20 / 100
#8 x 3-1/8"					17634	10 / 100

- Pro-Paks need to be ordered in multiples of two
- 2" bit included in Pro-Paks. 1" bit with Handy-Paks



APPLICATIONS:

- Exterior Trim
- cPVC Deck Boards
- Hidden Fastening Systems

PHEINOX™ STAINLESS STEEL SCREWS

PHEINOX™ 305 CORROSION RESISTANCE FOR HIGH MOISTURE ENVIRONMENTS

PHEINOX™ 316 MARINE GRADE PROTECTION FOR SUPERIOR CORROSION RESISTANCE



GRK's PHEINOX™ line of stainless steel fasteners feature designs from R4, RSS, Fin/Trim, and RT Composite screws in corrosion and stain resistant material.

GRK recommends PHEINOX™ 305 stainless steels screws for applications that require superior corrosion resistance in exterior environments with high moisture content, such as docks, boardwalks, pools, and hot tubs. PHEINOX™ 305 stainless is also recommended for use with cedar, redwood and various other wood species that have higher acid content. PHEINOX™ 305 stainless steels screws are recommended for applications located more than 1 mile from the coast.

PHEINOX™ 316 stainless steels screws are recommended for applications where extreme corrosion resistance is necessary, such as environments with high exposure to chlorides- such as de-icing salts- and in coastal applications within 1 mile of the coast. They are also suitable for use in chemically treated wood and naturally-protected wood such as cedar and redwood.

PHEINOX™ 305 Stainless Steel

- For use in cedar, redwood, specialty hardwood, IPE, and Mangaris
- Corrosion resistance for wet environments
- Stain resistant in specialty wood

PHEINOX™ 316 Stainless Steel

- For use within 1 mile of the coast
- Marine-Grade protection for superior corrosion resistance
- Superior Corrosion resistance for coastal environments
- Stain resistant in specialty wood











ESR-2442



ESR-3201



AC257 Treated
Lumber Approved

	U.S. (Std.) Size (Dia. x Length)	Bulk Part No.	Bulk Box Qty.	Pro-Pak Part No.	Pro-Pak Pail Qty.	Handy-Pak Part No.	Handy-Pak MC Qty./Screw Qty. (per EA)
	R4™ Screws: PHEINOX™ 305						
 T-25	#10 x 2-1/2"	25133	2,500	61633	240	61733	4 / 80
	#10 x 3-1/8"	25137	1,500	61637	210	61737	4 / 70
	RSS™ Screws: PHEINOX™ 305						
 T-30	5/16" x 3-1/8"	30221	500			62225	4 / 45
	5/16" x 4"	30225	400			132231	4 / 40
	5/16" x 5-1/8"						
	5/16" x 6"	30235	300				
	RT COMPOSITE™ Trim Screws: PHEINOX™ 305						
 T-10	#8 x 2"			36077	600		
	#8 x 2-1/2"	35079	3,500	36079	560	37079	20 / 100
 T-15	#9 x 2-1/2"			36101	365		
	FIN / TRIM™ Screws: PHEINOX™ 305						
 T-10	#8 x 1-1/2"					37724	20 / 100
	#8 x 2"			61728	510	67728	6 / 100
	#8 x 2-1/2"			61730	420	67730	6 / 100
	#8 x 3-1/8"			36734	385	37734	10 / 100
 T-15	#9 x 2-1/2"			36752	365		
	R4™ Screws: PHEINOX™ 316						
 T-25	#10 x 2-1/2"					137133	4 / 80
	#10 x 3-1/8"					137147	4 / 70
	FIN / TRIM™ Screws: PHEINOX™ 316						
 T-10	#8 x 2-1/2"					147730	6 / 100

• 2" bit included in Pro-Paks. 1" bit with Handy-Paks



APPLICATIONS:

- Boardwalks
- Pool Decks
- Spas

LOW PROFILE CABINET™

CABINET SCREWS



QUICK AND SECURE INSTALLATION

GRK's Cabinet screws are designed for use in cabinet construction and installation. Cabinet screws are manufactured in a #8 gauge (4 mm) diameter for universal size convenience.

- **Star Drive Recess:** Zero stripping, with 6 points of contact
- **Zip-Tip™:** Eliminates pre-drilling¹
- **W-Cut™:** Low torque, faster drive
- **Washer Head:** Creates a flush, clean hold for a strong and secure installation
- **Climatek™ Coating:** ICC-ES AC257 code approved for use in treated lumber²
- **White Cabinet Coating:** Color matched for interior applications
- For interior / exterior³ use



**AC257 Treated
Lumber Approved**

1. Zip-Tip included on fasteners 1-1/4" and longer
2. For cedar, redwood, and other naturally-protected woods, GRK recommends PHEINOX™ stainless steel fasteners
3. White Cabinet Coating only suitable for interior use



T-15

U.S (Std.) Size (Dia. x Length)	Bulk Part No.	Bulk Box Qty.	Pro-Pak Part No.	Pro-Pak Pail Qty.	Handy-Pak Part No.	Handy-Pak MC Qty./Screw Qty. (per EA)
#8 x 1"					96050	6 / 100
#8 x 1-1/4"	10069	4,000	100069	330	114069	6 / 100
#8 x 1-1/2"	10073	3,000	100073	330	114073	6 / 100
#8 x 1-3/4"	10075	2,000			12075	10 / 100
#8 x 2"	10077	2,000	96077	330	113077	4 / 100
#8 x 2-1/2"	10079	1,500	110079	330	113079	4 / 100
#8 x 2-3/4"					113081	4 / 100
#8 x 3-1/8"	10083	1,000	110083	270	114083	6 / 50

White Low Profile[™] Cabinet Screws



T-15

#8 x 1-1/4"					120680	6 / 80
#8 x 1-1/2"					120670	6 / 80
#8 x 2-1/2"					120660	6 / 80

- Pro-Paks need to be ordered in multiples of two
- 2" bit included in Pro-Paks



APPLICATIONS:

- Cabinet Construction & Installations
- Trim & Moulding
- Light-Duty Framing

TOP STAR™

ADJUSTABLE SHIM SCREWS



FOR PLUMB INSTALLATION OF WOODEN DOORS AND WINDOWS. NO MORE SHIMS!

GRK's adjustable Top Star™ shim screw is a screw within a screw that allows you to install wooden doors or windows without the use of shims. The quick and easy system reduces labor and allows for hassle free adjustment to ensure plumb installation.

The 4-point top sleeve provides a secure hold into the frame, while the GRK Star Drive bit is used to make the adjustments needed for a perfect, shim-free installation.

The Top Star's highly-engineered system can be used for installation of wooden doors, windows, insulation, paneling, wall-units, and cabinets.

- **Recessed Star Drive:** Zero stripping, with 6 points of contact
- **4-point 3/8" Diameter Threaded Sleeve** provides a secure hold in your wooden frame
- **Micro-Adjustments** allow for an absolute plumb installation
- **Use with GRK's Top Star™ Crown and T-15 Star Bit System**
- **Zinc Plated** finish for lasting durability
- **For Shim Free Installation** of wooden doors, windows, insulations, paneling, built-in wall units, and cabinets

U.S (Std.) Size (Dia. x Length)	Pro-Pak Part No.	Pro-Pak Pail Qty.
3/8" x 2-1/2"	20157	100
3/8" x 3-1/8"	20161	100

• Pro-Paks need to be ordered in multiples of two

The Complete Top Star™ System Includes:

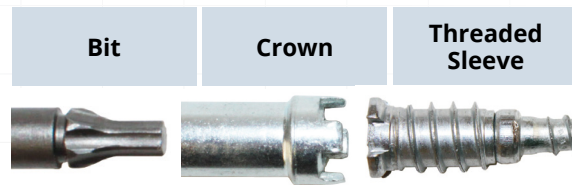

Crown / Bit	Blister-Pak Part No.	Blister-Pak Qty.
Includes: (1) Crown / Bit with each	86465	1

• 5/16" drill bit not included

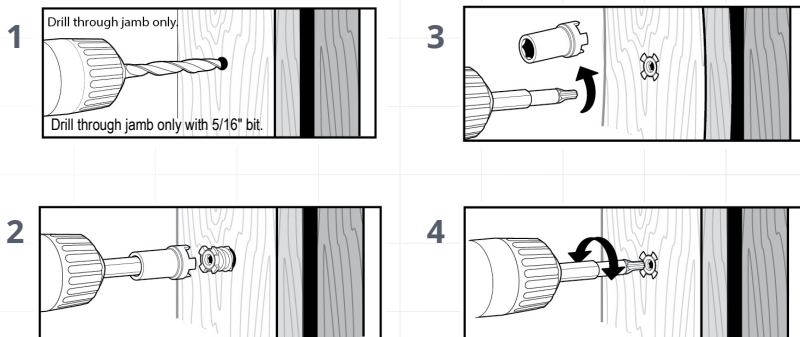

The Bit drives the Top Star™ into the material when the Crown and Bit are combined. Using the Bit without the Crown adjusts the distance.

The Threaded Sleeve moves independently from the Top Star™ unless locked by the Crown. When locked, the Top Star™ gets driven into the material.

Unlocked, the installed Top Star™ is ready for leveling.

APPLICATIONS:

- Wooden Doors
- Windows
- Insulation



CALIBURN™ CONCRETE SCREW



HEAVY DUTY CONCRETE AND MASONRY FASTENER

Caliburn™ Concrete screws are professionally engineered fasteners with a patented thread design for ease of driving the screw into concrete and similar applications.

- **Star Drive Recess:** Zero stripping, with 6 points of contact
- **Aggressive Heavy Duty Threads** lock into concrete and can be removed/reinserted without screw damage
- **Caliburn™ XL:** washer head design for superior holding power
- **Climatek™ Coating:** ICC-ES AC257 code approved for use in treated lumber
- Ideal for use in anchoring to concrete or wood to concrete applications including basement framing and sheds

APPLICATIONS:

- Wood to Concrete Framing
- Electrical and Plumbing Fixtures
- Caliburn XL for Heavy Duty Concrete Anchoring



U.S (Std.) Size (Dia. x Length)	Bulk Part No.	Bulk Box Qty.	Handy-Pak Part No.	Handy-Pak MC Qty./Screw Qty. (per EA)
Caliburn™ XL				
19/64" x 2-3/4"			57774	10 / 25
19/64" x 3-1/2"	55778	400	57778	10 / 25
19/64" x 5"			57785	10 / 25

• 1" bit included in Handy-Paks

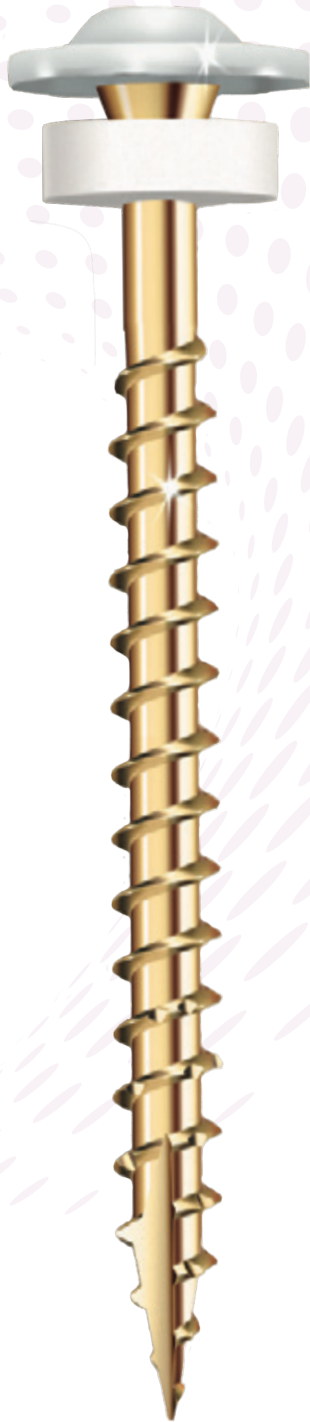

POWDER COATED HEAD FOR A CLEAN FINISHED LOOK

This screw has an integrated washer-head and is complemented by a rubber washer below the screw head. This feature also helps protect the washer from prolonged exposure to the sun for long lasting, secure siding installations.

- **White Color, Low Profile Head** produces a clean, finished look which is preferred for moldings, closet organizers, and metal siding
- **Washer Head** increases holding power
- **Rubber Washer:** seals drill hole from the elements
- **W-Cut™ Thread Design** tiny saw blades reduce torque by cutting through the material
- **ZIP-TIP™** for easy starts and no pre-drilling
- For use in interior or exterior applications including metal siding, garage door trim, and even closet organizers. Not for use with treated lumber

APPLICATIONS:

- Metal Siding
- Garage Door Trim
- Closet Organizers



T-25

U.S (Std.) Size (Dia. x Length)	Bulk Part No.	Bulk Box Qty.
#9 x 1-1/2"	40090	3000

- 1" bit included in Handy-Paks

STAR DRIVE BITS

CROWN / BIT



Bit Size	Bit Color	Fits	Bulk Part No.	Bulk Box Qty.	Carded Part No.	Carded Qty/per pack
T-10 2" T-10 3"	Yellow Yellow	Trim™ Head #8	86419	25	187419 87421	2 2
T-15 2" T-15 3"	Red Red	R4™ Screw #6 & 8 Trim™ Head #9 Cabinet™ Screw	86427	25	187427 87429	2 2
T-20 2"	Purple		86435	25	187435	2
T-25 2" T-25 3"	Green Green	R4™ #9,10 & 12 RSS™ #10 & 1/4" MSS™ #9	86443	25	187443 87445	2 2
T-30 2" T-30 3"	Black Black	RSS™ Structural Screw 5/16" Caliburn™ & Caliburn PH™	86451	25	187451 87453	2 2
T-40 2"	Blue	Caliburn XL™ Screws RSS™ Structural Screw 3/8"	86459	25	187459	2

Crown/Bit						
		TOP STAR™			86465	1





STAR DRIVE BITS & ACCESSORIES



LIABILITY AND WARRANTIES

GRK Fasteners™ (“GRK”) is a distributor of commercial-grade fasteners. The parts that we supply are quality inspected by independent labs.

We maintain lot traceability on all products listed in this catalog as long as they are in their original bulk boxes. Certifications are maintained on all fasteners.

Hydrogen Embrittlement: GRK takes measures during production of all fasteners to mitigate hydrogen embrittlement, including post-coating baking. These processes, however, do not guarantee that hydrogen embrittlement will not still be present or that it will not occur at a later date while in service. Specialized testing or a substitute part may be required, depending on the application.

GRK Warranty: GRK warrants to the first retail purchaser that its Climatek™ coated, Deck Elite coated, and PHEINOX™ stainless steel screws will not rust under normal environmental conditions when used in accordance with the recommendations listed in this catalog. This warranty is not transferable. Visit www.grkfasteners.com for more information.

LIABILITY AND WARRANTIES

Mechanical Fastening Warranty: (Includes GRK Fasteners, Tapcon, Red Head, Ramset, Teks, Rock-On, Backer-On, and E-Z Anchor). ITW Brands warrants that these products are free from defects in material and workmanship. ITW Brands's sole liability for any breach of this warranty shall be to replace this product or refund the purchase price.

Liability: Claims against GRK or ITW Brands shall be limited to a refund or credit for the price billed or paid for faulty or incorrect merchandise. Seller shall not be responsible for buyer's manufacturing costs, labor, alternate purchases, extra freight, replating, plating, lost profit, good will, recall costs, or other incidental or consequential damages.

Refunds/Replacements: In order to request a refund or replacement, please contact ITW Customer Service at BrandsCS@itwbrands.com or 877 489-2726 to start the process.

THERE ARE NO UNDERSTANDINGS, AGREEMENTS, REPRESENTATIONS, OR ADDITIONAL WARRANTIES, EXPRESSED OR IMPLIED (INCLUDING ANY REGARDING WARRANTIES OF MERCHANTABILITY OR FITNESS FOR A PARTICULAR PURPOSE), NOT SPECIFIED HEREIN, RESPECTING ANY SALE OF PRODUCTS BY GRK FASTENERS™ (TO THE EXTENT PERMITTED BY LAW).



paslode.com



grkfasteners.com



tapcon.com



backeronrockon.com



ramset.com



teksscrews.com



redheadanchoring.com



easyanchors.com

FULL-LINE CATALOG



Part #99915
August 2022

ITW CONSTRUCTION | RESIDENTIAL AND RENOVATION
Glenview, IL 60025